

# Panasonic

Model No. **KX-TGE260/KX-TGE262/KX-TGE263**  
**KX-TGE264/KX-TG454SK/KX-TGE270**  
**KX-TGE272/KX-TGE273/KX-TGE274**  
**KX-TGE275/KX-TG465SK**

## Quick Guide

### Connections

#### Base unit

- ① Connect the AC adaptor to the unit by pressing the plug firmly.
- ② Fasten the cord by hooking it.
- ③ Connect the AC adaptor to the power outlet.
- ④ Connect the telephone line cord to the unit, then to the single-line telephone jack (RJ11C) until you hear a click.
- ⑤ A DSL/ADSL filter (not supplied) is required if you have a DSL/ADSL service.

#### Note:

- Use only the supplied Panasonic AC adaptor PNLV226.

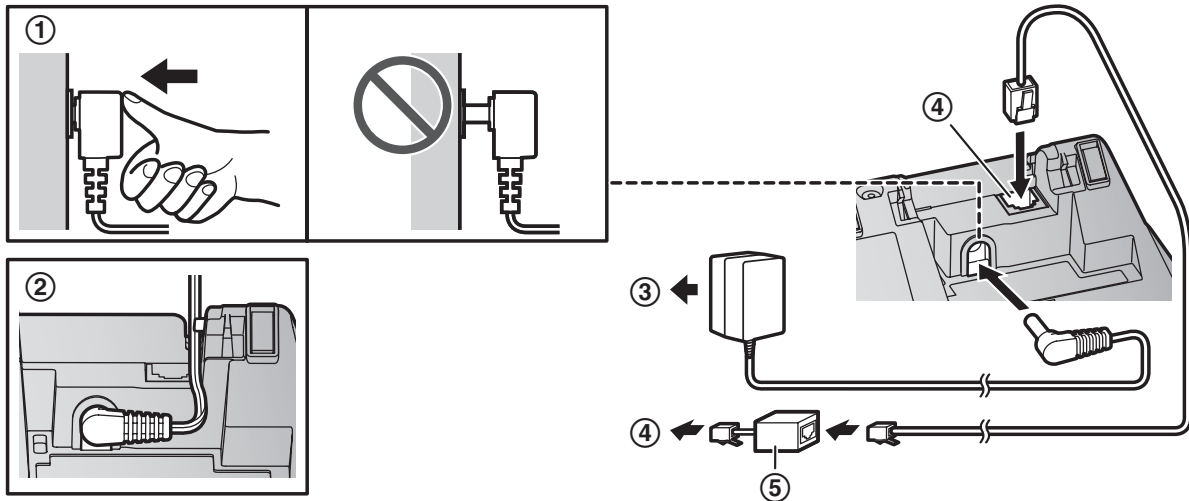

#### Charger

- ① Connect the AC adaptor to the power outlet.

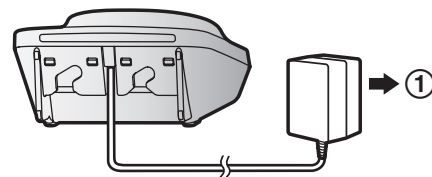

## Battery installation/Battery charging

Charge for about 7 hours.

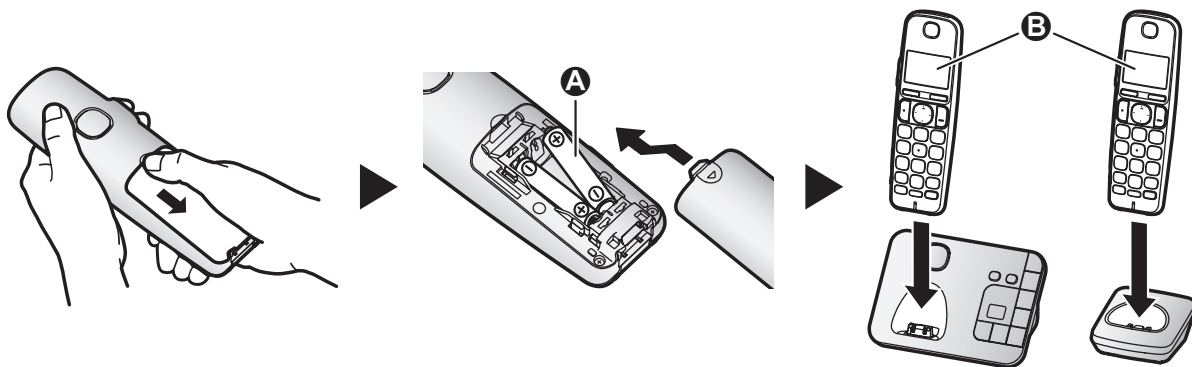

### Note:

- USE ONLY rechargeable Ni-MH batteries AAA (R03) size (A).
- Do NOT use Alkaline/Manganese/Ni-Cd batteries.
- Confirm correct polarities (+, -).
- Follow the directions on the display to set up the unit.
- Confirm “Charging” is displayed (B).

## Operating tips

### Soft keys

By pressing a soft key, you can select the feature shown directly above it on the display. Pay attention to the display to see what functions the soft keys are assigned during operation.

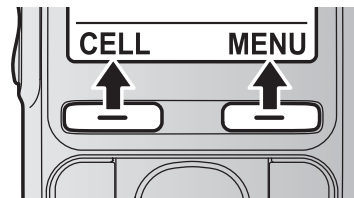

### Navigator key

- [▲], [▼], [◀], or [▶]: Scroll through various lists and items.
- ◀ (Volume: [▲] or [▼]): Adjust the receiver or speaker volume while talking.
- [◀] ☐☐: View the phonebook entry.
- [▶] REDIAL: View the redial list.
- [▼] CID (Caller ID): View the caller list.

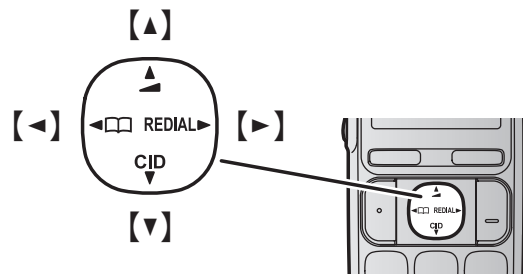

## Date and time (Handset)

- 1 [MENU]#101
- 2 Enter the current month, date, and year. → [OK]
- 3 Enter the current hour and minute (12-hour clock format).
- 4 [X]: Select “AM” or “PM”. → [SAVE] → [OFF]

## Recording your greeting message for the answering system for the landline (Handset)

If you use a pre-recorded greeting message, you do not need to record your own greeting message.

- 1 **[MENU]** **#** **3** **0** **2** → **[↓]**: “Yes” → **[SELECT]**
- 2 After a beep sounds, hold the handset about 20 cm (8 inches) away and speak clearly into the microphone (2 minutes max.).
- 3 Press **[STOP]** to stop recording. → **[OFF]**

## Link to cell

You can connect your base unit and cellular phone using Bluetooth® wireless technology, so that you can make or answer cellular calls using your phone system. For more details, please visit our Web site: <http://www.panasonic.com/link2cell>

- Locate your cellular phone near the base unit. If the cellular phone is too close to the base unit during a cellular call, you may hear noise. For best performance, we recommend placing the cellular phone between 0.6 m to 3 m (2 feet to 10 feet) away from the base unit.

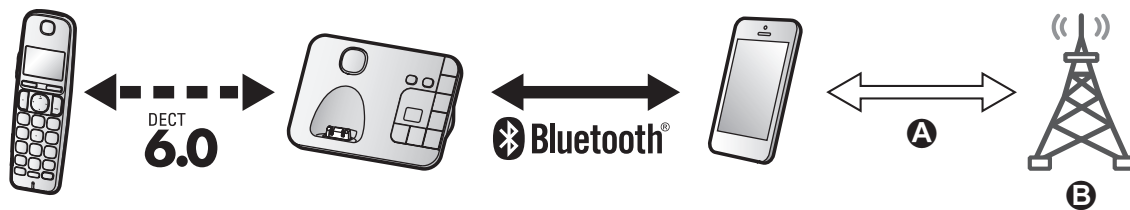

- A** Cell line
- B** Cell phone service providers

### Trademarks

- The Bluetooth® word mark and logos are registered trademarks owned by Bluetooth SIG, Inc., and any use of such marks by Panasonic Corporation is under license.
- All other trademarks identified herein are the property of their respective owners.

# Link to cell

## Pairing a Bluetooth cellular phone

### 1 Handset:

For CELL 1: **[MENU] # 6 2 4 1**

For CELL 2: **[MENU] # 6 2 4 2**

- After the corresponding CELL indicator on the base unit starts flashing, the rest of the procedure must be completed within 5 minutes.

### 2 Your cellular phone:

While the corresponding CELL indicator is flashing, follow the instructions of your cellular phone to enter the pairing mode.

- Depending on your cellular phone, it may ask you to enter the Bluetooth PIN (default: "0000"). If your cellular phone shows PassKey confirmation on its display, follow the directions to proceed.

### 3 Handset:

Wait until a long beep sounds.

- It may take more than 10 seconds to complete pairing.
- When the corresponding CELL indicator lights up, the cellular phone is connected to the base unit. You are ready to make cellular calls.

### 4 [OFF]





#### Note:

- Make sure that your cellular phone is set to connect to this product automatically. Refer to your cellular phone's operating instructions.

## Base unit: CELL indicators

Status	Meaning
On	A cellular phone is connected. Ready to make/receive cellular calls.
Flashing	<ul style="list-style-type: none"> <li>– The cellular line is in use.</li> <li>– Phonebook entries are being copied from a cellular phone.</li> <li>– The base unit is searching for the paired cellular phone.</li> <li>– The base unit is pairing a cellular phone.</li> <li>– A cellular call is put on hold.</li> </ul>
Flashing rapidly	A cellular call is being received.
Light off	<ul style="list-style-type: none"> <li>– A cellular phone is not paired to the base unit.</li> <li>– A cellular phone is not connected to the base unit.</li> </ul>

## Handset: Link to cell display items

 <sup>1</sup>	<p>A cellular line is in use.*<sup>1</sup></p> <ul style="list-style-type: none"> <li>• When flashing: The cellular call is put on hold.</li> <li>• When flashing rapidly: A cellular call is being received.</li> </ul> <p>*<sup>1</sup> Corresponding cellular line(s) is(are) indicated next to the item.</p>
 <sup>1</sup>	<p>A cellular phone is connected.*<sup>1</sup> Ready to make/receive cellular calls.</p> <ul style="list-style-type: none"> <li>• When turned off: A cellular phone is not connected to the base unit.</li> </ul> <p>*<sup>1</sup> Corresponding cellular line(s) is(are) indicated next to the item.</p>
 	<ul style="list-style-type: none"> <li>– A cellular call is being done on that line.</li> <li>– The cellular line is selected for the setting.</li> </ul>

## Link to cell

### Connecting/disconnecting the cellular phone

#### Auto connection to the Bluetooth devices (cellular phones or headset)

The unit connects to the Bluetooth devices at regular intervals if the connection is lost. To change the interval (default: “1 min”), see the operating instructions.

- When 3 Bluetooth devices (2 cellular phones and 1 headset) are paired to the base unit, only 2 Bluetooth devices can be used with the unit at the same time, and the base unit loses its connection from other Bluetooth devices. To automatically resume the connection to Bluetooth devices, leave the auto connection on.

#### Connecting/disconnecting the cellular phone manually

If you will not be using the paired cellular phone’s link to cell feature temporarily (for example, you do not want the unit to ring when your cellular line receives a call), you can disconnect your cellular phone from the base unit. If you want to use it again, reconnect the cellular phone to the base unit.

- Even if a paired cellular phone was disconnected from the base unit, if it is brought within the base unit’s range during the auto connection interval, it may automatically connect to the base unit.
- A disconnected cellular phone is not unpaired from the base unit, so pairing it to the base unit again is unnecessary.

#### 1 To connect/disconnect:

For CELL 1: **[MENU]#6251** (A long beep sounds.)

For CELL 2: **[MENU]#6252** (A long beep sounds.)

#### 2 [OFF]

### Cellular line only mode (If you do not use the landline) (Handset)

If you do not use the landline, set the cellular line only mode to use this unit more conveniently.

- If you turn on the “Cell line only mode”, disconnect the telephone line cord from the base unit. Otherwise the “Cell line only mode” cannot be activated.

#### 1 [MENU]#157

#### 2 To turn on:

**[↕]: “On” → [SELECT] → [↕]: “Yes” → [SELECT]**

To turn off:

**[↕]: “OFF” → [SELECT]**

## Basic operations

### Making/Answering calls (Handset)

Making cellular calls	<b>1</b> Dial the phone number. → <b>[CELL]</b> <ul style="list-style-type: none"> <li>• When the cellular line only mode is set, you can also press <b>[↶]/[☎]</b> instead of <b>[CELL]</b>.</li> <li>• When only 1 cellular phone is paired, the unit starts dialing.</li> </ul> <b>2</b> When 2 cellular phones are paired: <b>[↕]:</b> Select the desired cellular phone. → <b>[SELECT]</b>
Making landline calls	Dial the phone number. → <b>[↶]/[☎]</b>
Answering calls	<b>[↶]/[☎]/[NR]</b>
To hang up	<b>[OFF]</b>

## Basic operations



### Making/Answering calls (Handset)

To adjust the receiver/ speaker volume	Press <b>[+]</b> or <b>[-]</b> repeatedly while talking.
Making a call using the redial list	<b>1</b> <b>[▶]</b> REDIAL → <b>[↕]</b> : Select the desired phone number. <b>2</b> <b>To make a cellular call:</b> When only 1 cellular phone is paired: <b>[CELL]</b> or When 2 cellular phones are paired: <b>[CELL]</b> → <b>[↕]</b> : Select the desired cellular phone. → <b>[SELECT]</b> <b>To make a landline call:</b> <b>[↶]</b>
To adjust the ringer volume (cellular line/landline)	Press <b>[+]</b> or <b>[-]</b> repeatedly to select the desired volume while ringing.

### Making/Answering calls (Base unit: KX-TGE270 series)

Making cellular calls	<b>[CELL 1]/[CELL 2]</b> → Dial the phone number. When the cellular line only mode is set, you can also press <b>[☎]</b> instead of <b>[CELL 1]/[CELL 2]</b> .
Making landline calls	<b>[☎]</b> → Dial the phone number.
Answering calls	<b>[☎]</b>
To hang up	<b>[☎]</b>
To adjust the speaker volume	Press <b>[+]</b> or <b>[-]</b> repeatedly while talking.
Making a call using the redial list	<b>1</b> <b>To make a cellular call: [CELL 1]/[CELL 2]</b> <b>To make a landline call: [☎]</b> <b>2</b> <b>[REDIAL]</b>
To adjust the ringer volume (cellular line/landline)	Press <b>[+]</b> or <b>[-]</b> repeatedly to select the desired volume while ringing.

## Basic operations

Phonebook (Handset)	
Adding entries	<ol style="list-style-type: none"> <li>1 [<b>&lt;</b>]  → [<b>MENU</b>]</li> <li>2 [<b>↕</b>]: “Add new entry” → [<b>SELECT</b>]</li> <li>3 Enter the party’s name (16 characters max.). → [<b>OK</b>]</li> <li>4 Enter the party’s phone number (24 digits max.). → [<b>OK</b>]</li> <li>5 [<b>↕</b>]: Select the desired group. → [<b>SELECT</b>] 2 times → [<b>OFF</b>]</li> </ol>
Making calls	<ol style="list-style-type: none"> <li>1 [<b>&lt;</b>]  → [<b>↕</b>]: Select the desired entry.</li> <li>2 <b>To make a cellular call:</b> When only 1 cellular phone is paired: [<b>CELL</b>] or When 2 cellular phones are paired: [<b>CELL</b>] → [<b>↕</b>]: Select the desired cellular phone. → [<b>SELECT</b>]</li> <li><b>To make a landline call:</b> [<b>↶</b>]</li> </ol>
Answering system for the landline (Base unit)	
Answering on/off	Press [ <b>ANSWER ON/OFF</b> ] to turn on/off the answering system.
Listening to messages	[ <b>▶■</b> ] (PLAY)
Answering system for the landline (Handset)	
Listening to messages	<p><b>To listen to new messages:</b> [<b>PLAY</b>] or [<b>MENU</b>]#<b>3</b><b>2</b><b>3</b></p> <p><b>To listen to all messages:</b> [<b>MENU</b>]#<b>3</b><b>2</b><b>4</b></p>

## Using Bluetooth devices

### Copying phonebook entries from a Bluetooth cellular phone (phonebook transfer)

You can copy phonebook entries from the paired cellular phones or other cellular phones (not paired) to the unit's phonebook.

**1 Handset:** **[MENU]** **#** **6** **1** **8**

**2 Handset:**

**To copy from paired cellular phones:**

**[↕]:** Select the desired cellular phone. → **[SELECT]**

- Copied items are stored to the group ("Cell 1" or "Cell 2") which the cellular phone is paired to.

**To copy from other cellular phones (not paired):**

**[↕]:** "Other cell" → **[SELECT]** → **[↕]:** Select the group you want to copy to. → **[SELECT]**

**3** When "Use the cell to transfer phone book" is displayed: Go to step 4.

**When "Select mode" menu is displayed:**

**[↕]:** Select "Auto" or "Manual". → **[SELECT]**

"Auto": Download all entries from the cellular phone automatically. Go to step 5.

"Manual": Copy entries you selected.

- "Select mode" menu is displayed only when the cellular phone supports PBAP (Phone Book Access Profile) for Bluetooth connection.

**4 Cellular phone:**

Follow the instructions of your cellular phone to copy phonebook entries.

- For other cellular phones (not paired), you need to search for and select the base unit. The Bluetooth PIN (default: "0000") may be required. If your cellular phone shows PassKey confirmation on its display, follow the directions to proceed.
- The entries being copied are displayed on the handset.

**5 Handset:**

Wait until "Completed" is displayed. → **[OFF]**



# Using Bluetooth devices

## Using a Bluetooth wireless headset (optional) for landline calls

By pairing a Bluetooth headset to the base unit, you can have a hands-free conversation wirelessly for landline calls.

- Only 2 Bluetooth devices can be used with the unit at the same time (for example, 2 cellular lines, or the headset and 1 cellular line).

### Pairing a headset to the base unit

#### 1 Your headset:

Set your headset to pairing mode.

- Refer to your headset operating instructions.

#### 2 Handset:

**[MENU]# 6 2 1**

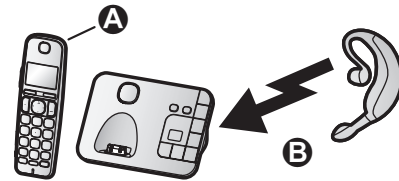

**A** Pair using the handset.

**B** Pairing

#### 3 If your headset PIN is “0000”, go to step 4.

**If your headset PIN is other than “0000”, press [CLEAR], then enter your headset PIN.**

- Typically, default PIN is “0000”. Refer to the headset operating instructions.

#### 4 Press [OK], then wait until a long beep sounds. → [OFF]

- When the HEADSET indicator on the base unit lights up, you are ready to use the headset.

### Operating a Bluetooth wireless headset using a landline

Refer to your headset operating instructions for headset operations.

#### ■ Answering landline calls with your headset

To answer a landline call, turn on your headset referring to your headset operating instructions. When you finish talking, turn off your headset referring to your headset operating instructions.

- If you cannot hang up the call using your headset:
  - press **[▶■]** (STOP) on the base unit. (KX-TGE260 series)
  - press **[📞]** on the base unit 2 times. (KX-TGE270 series)

#### ■ Switching between the base unit and your headset

You can switch between the base unit and your headset:

- during a landline call with the base unit speakerphone. (KX-TGE270 series)
- during an intercom call between the base unit and handset. (KX-TGE270 series)
- while listening to messages recorded on the base unit answering system.

#### To switch to your headset:

Turn on the headset referring to your headset operating instructions.

#### To switch to the base unit (KX-TGE270 series):

Press **[📞]** on the base unit.

## Frequently asked questions

Question	Cause/solution
Why is  displayed?	<ul style="list-style-type: none"> <li>● The handset is too far from the base unit. Move closer.</li> <li>● The base unit's AC adaptor is not properly connected. Reconnect AC adaptor to the base unit.</li> <li>● The handset is not registered to the base unit. Register it.               <ol style="list-style-type: none"> <li><b>1 Handset:</b> <b>[MENU]</b><b>#</b><b>1</b><b>3</b><b>0</b></li> <li><b>2 Base unit:</b> Press and hold <b>[LOCATOR]</b> or <b>[HANDSET LOCATOR]</b> for about 5 seconds.</li> <li><b>3 Handset:</b> Press <b>[OK]</b>, then wait until a long beep sounds.</li> </ol> </li> </ul>
Why am I unable to pair a cellular phone to the base unit?	<ul style="list-style-type: none"> <li>● Depending on the compatibility of the cellular phone, you may not be able to pair it to the base unit. For more information, please visit <a href="http://www.panasonic.com/link2cell">http://www.panasonic.com/link2cell</a></li> <li>● Confirm that the Bluetooth feature of your cellular phone is turned on. You may need to turn this feature on depending on your cellular phone.</li> </ul>
How can I increase the handset volume level?	<ul style="list-style-type: none"> <li>● Press the volume key <b>[+]</b> repeatedly while talking.</li> </ul>
Why is the conversation noisy or cutting off?	<ul style="list-style-type: none"> <li>● Try to relocate the base unit so that distance to the handset is minimized.</li> <li>● If the same problem occurs even if the handset is next to the base unit, please visit: <a href="http://www.panasonic.com/support">http://www.panasonic.com/support</a></li> </ul>
Can I add another accessory handset to my base unit?	<ul style="list-style-type: none"> <li>● Yes, you can add up to 6 handsets (including the handset(s) sold with your base unit) to a single base unit.</li> <li>● To purchase additional accessory handset(s) (KX-TGEA20), please visit: <a href="http://www.pstc.panasonic.com">http://www.pstc.panasonic.com</a> TTY users (hearing or speech impaired users) can call 1-866-605-1277.</li> </ul>
Can I keep the batteries charging all the time?	<ul style="list-style-type: none"> <li>● You can leave the handset on the base unit or charger anytime. This will not harm the batteries.</li> </ul>
How can I answer a call waiting call (2nd call)?	<ul style="list-style-type: none"> <li>● Press <b>[CALL WAIT]</b> when you hear the call waiting tone.</li> </ul>